

urbān



STAINLESS STEEL DOOR HARDWARE



 **Trimco**



THE HANDLE OF A DOOR

is both a functional apparatus and adds a finishing touch to the decor and motif of a

room. TRIMCO has selected designs which bring together aesthetics, form and function. Through collaboration with designers, engineers and ergonomic experts from around the world, TRIMCO offers the architect and client over 30 styles from which to choose. With our manufacturing capabilities, we are also able to produce designs unique to your project, as well as finishes to meet the most demanding taste.

STAINLESS STEEL was invented in the early 1900s to answer a need for a very durable steel alloy. By adding chromium and nickel to low-carbon steel, an extremely strong alloy is made that has become the standard for strength and beauty. The addition of the chromium gives stainless its unique rust-resistant properties. Metallurgists found, during the development process, that the surface of the material developed a thin layer of oxide molecules. This layer acted as a protective film and when minor surface impairments occurred, the molecules rearranged themselves to repair the surface. Today, stainless steel is often referred to as a 'self-healing' material.

TRIMCO produces their levers from ASTM 304 stainless steel. ASTM 316 may be specified for applications that warrant, although there is a modest up-charge.

STAINLESS STEEL FINISHES – Natural SATIN and POLISHED stainless steel are the primary finishes offered by TRIMCO. These finishes reflect the natural beauty of the Nickel and Chrome, which are the essence of stainless steel.

TRIMCO is also the ideal resource for those seeking the highest quality custom designs. We are experts in high-performance materials like stainless steel and have built a reputation for superior workmanship and detailing unparalleled in the architectural hardware industry. With experience and a vast portfolio of successfully completed projects as well as the competency and facilities capable of handling projects of any scale, TRIMCO is a proven, reliable partner for your custom manufacturing needs.

Made from the finest materials,

TRIMCO presents the **urbān** series. These products are inspired by the world's great artists and composers, by the recollection of a fragrant aroma of a vintage wine, or the energy of a downtown metropolis. This unique collections allows for individual creativity and expression.

Urban levers meet ADA.

product notes: clockwise from top left

Bellini - #81SC001 - lever dimension: 5-1/8"

Matisse - #81ST037 - lever dimension: 5-3/8"

Calder - #81SC003 - lever dimension: 5"

Beethoven - #81SC562 - lever dimension: 4-5/8"

Mozart - #81SC563 - lever dimension: 5-1/4"

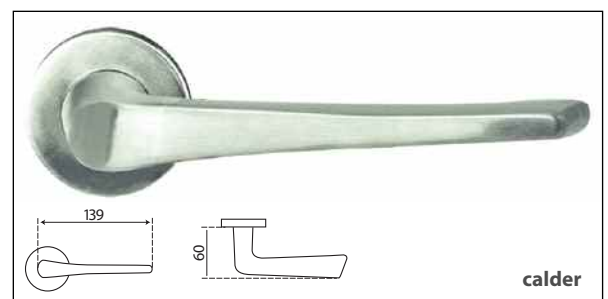
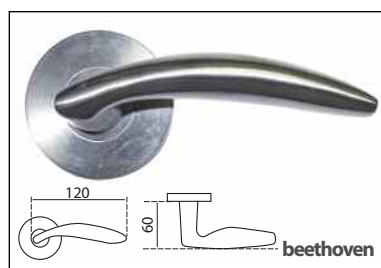
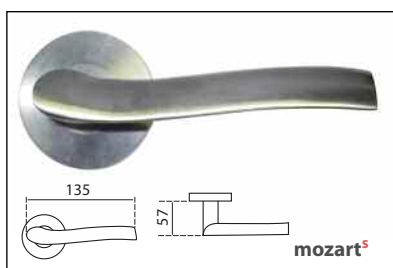
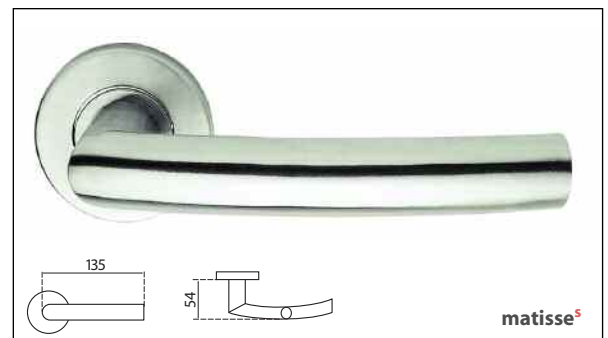
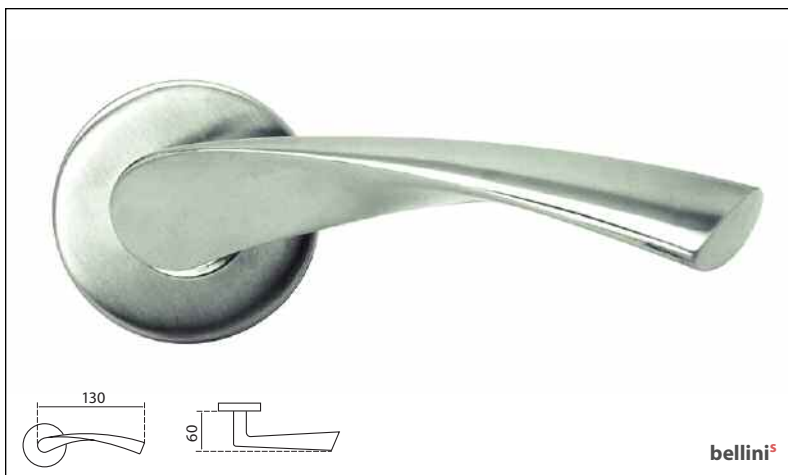

diagram measurements are mm

s = stocked in Los Angeles

urbān



product notes: clockwise from left

Handel - #81SC090 - lever dimension: 5"

Mahler - #81SC069 - lever dimension: 5-1/8"

Brahms - #81SC084 - lever dimension: 4-7/8"

da Vinci - #81SC020 - lever dimension: 5-3/4"

Bach - #81SC089 - lever dimension: 5-3/8"

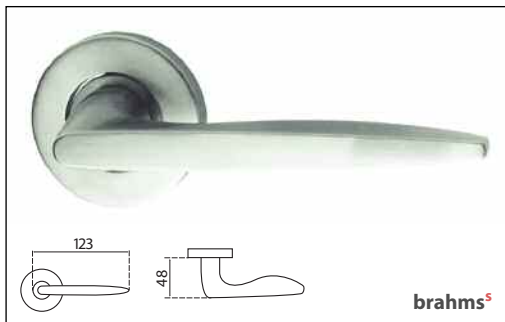
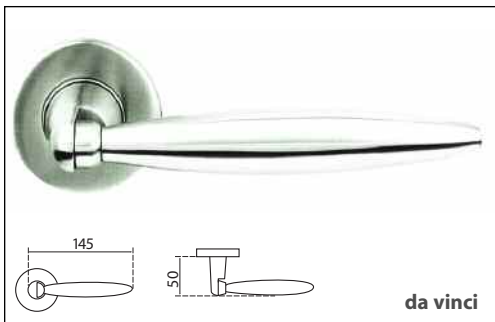
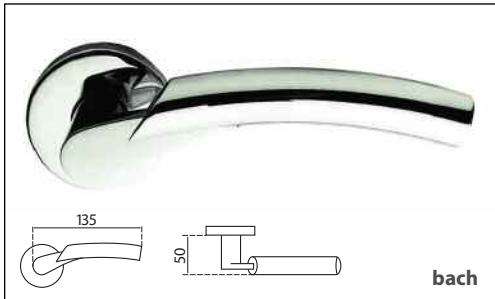
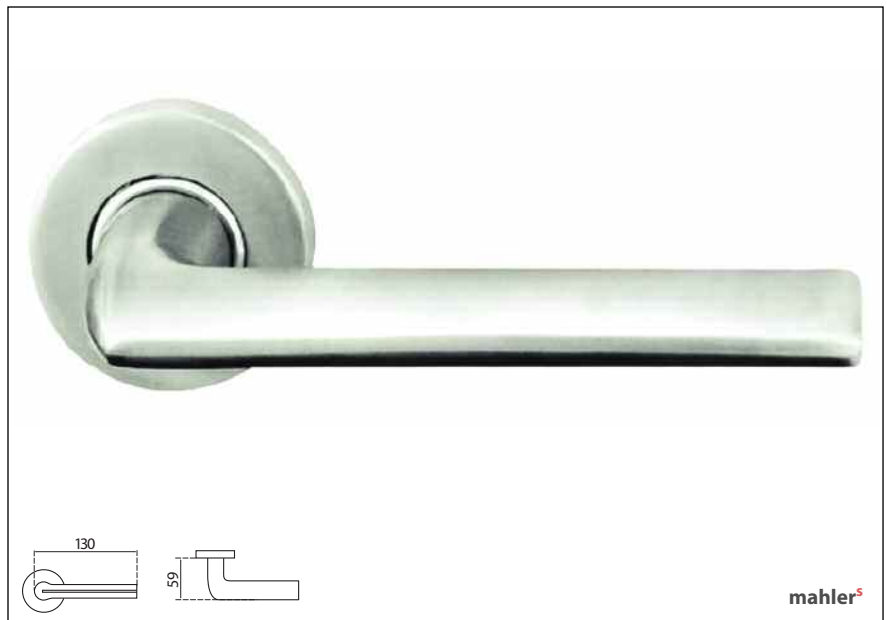
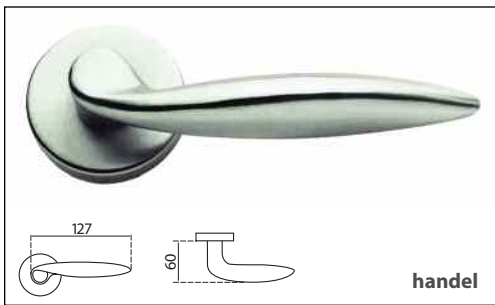

diagram measurements are mm

s = stocked in Los Angeles

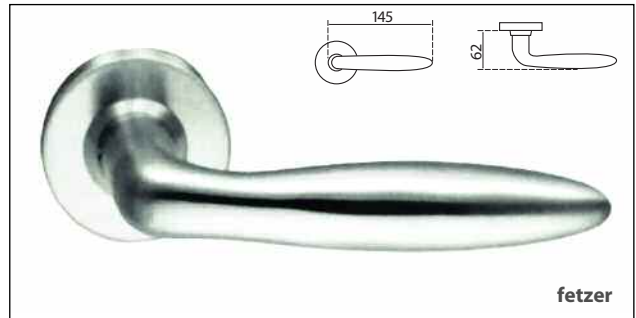
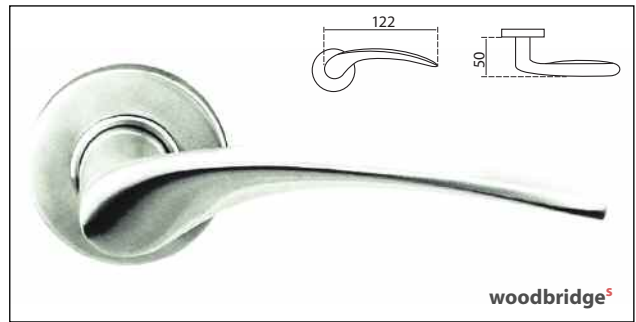
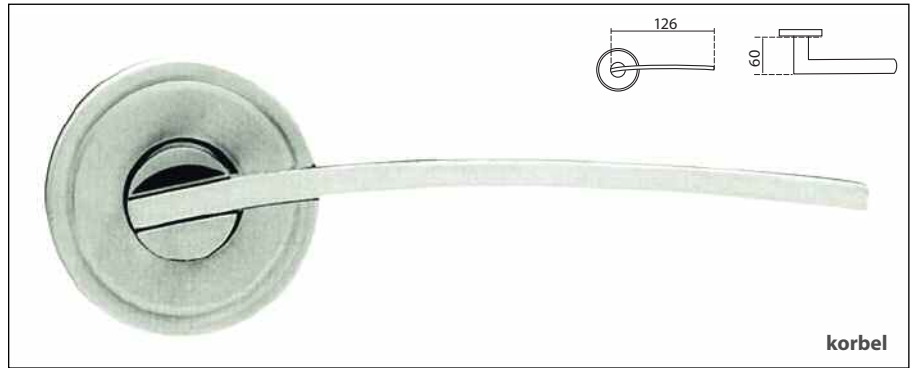
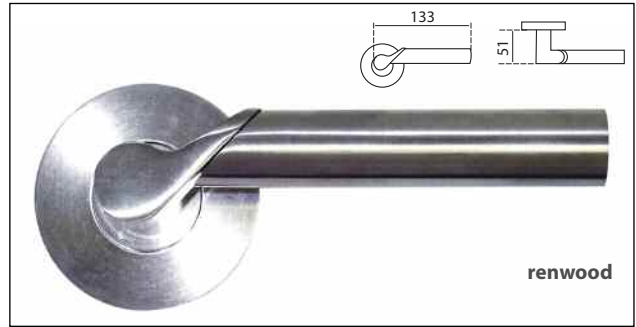

diagram measurements are mm

product notes: from top

Renwood - #81ST564 - lever dimension: 5-1/8"

Korbel - #81SC010 - lever dimension: 5"

Woodbridge - #81SC016 - lever dimension: 4-3/4"

Fetzer - #81SC026 - lever dimension: 5-1/8"

Herzog - #82SC007 - lever dimension: 5"

Herzog not available with combo pack.

s = stocked in Los Angeles

urbān

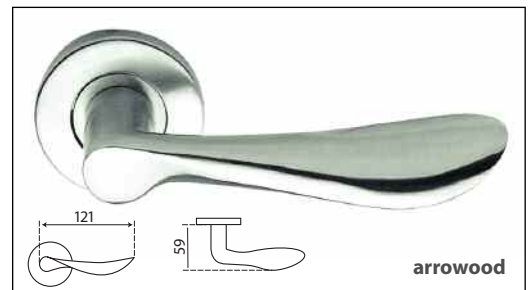
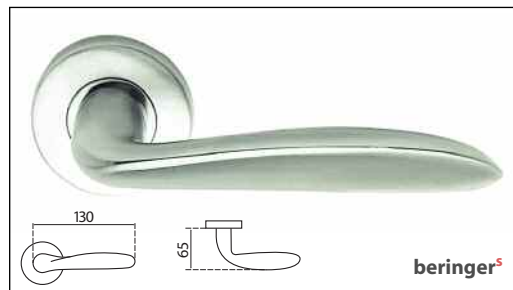
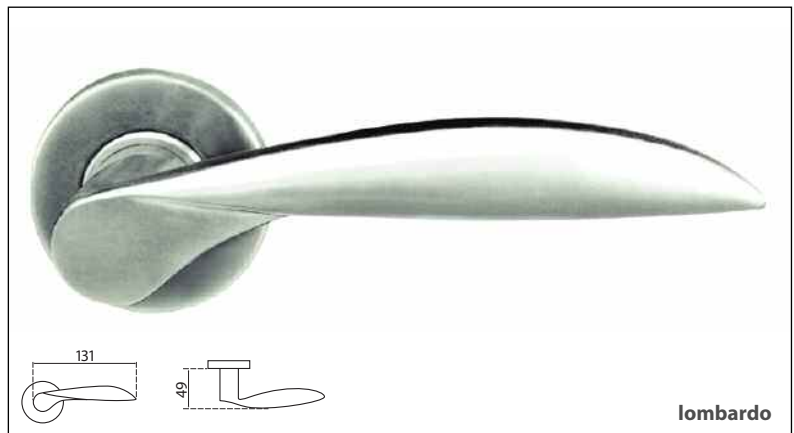
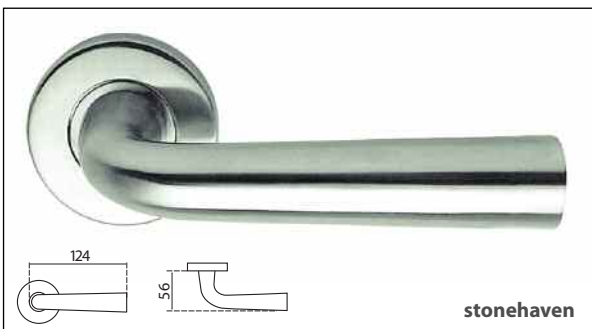

diagram measurements are mm

product notes: clockwise from top left

Fonseca - #81SC062 - lever dimension: 4-3/4"

Lombardo - #81SC053 - lever dimension: 5-1/8"

Arrowood - #81SC015 - lever dimension: 4-3/4"

Beringer - #81SC067 - lever dimension: 5-1/8"

Stonehaven - #81SC064 - lever dimension: 5-3/8"

s = stocked in Los Angeles

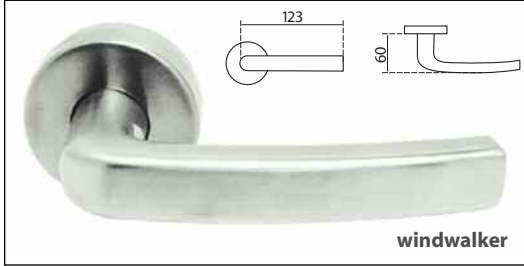

windwalker

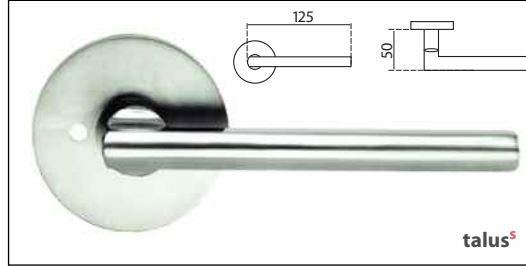

talus^s

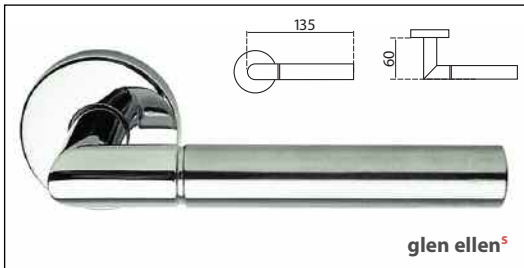

glen ellen^s



bolla

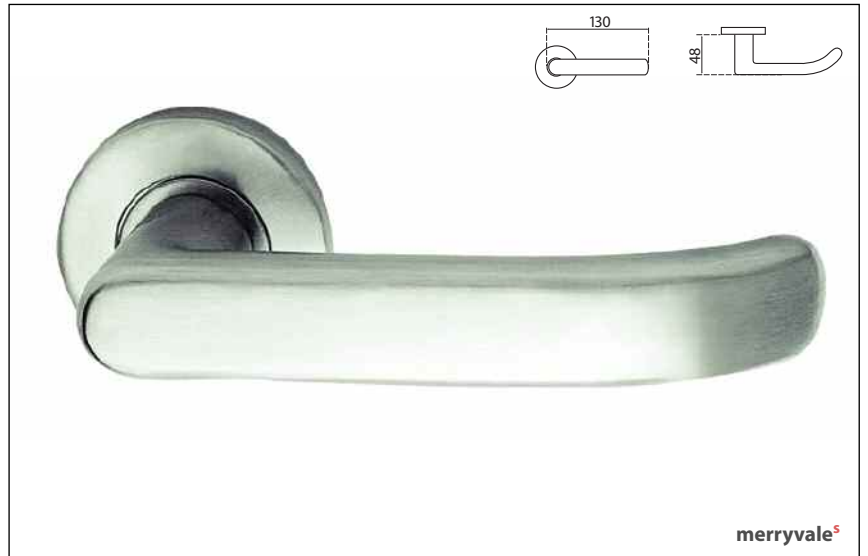

merryvale^s

diagram measurements are mm

- product notes:** clockwise from top left
Windwalker - #81SC030 - lever dimension: 4-7/8"
Talus - #81SC031 - lever dimension: 4-7/8"
Merryvale - #81SC051 - lever dimension: 5-3/8"
Bolla - #81SC012 - lever dimension: 4-3/4"
Glen Ellen - #81SC037 - lever dimension: 5-3/8"

urbān

s = stocked in Los Angeles

urbān

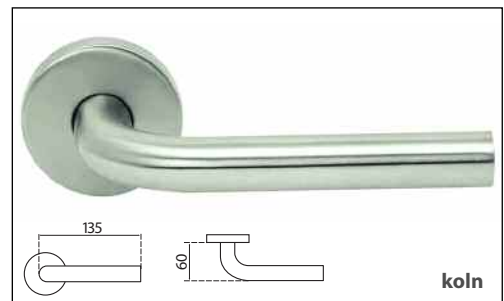
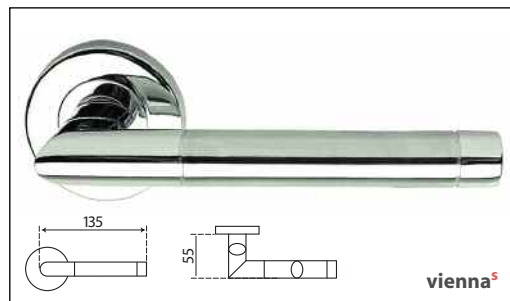
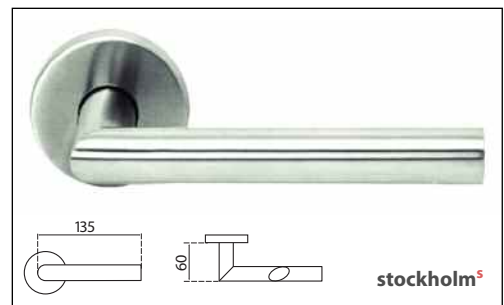
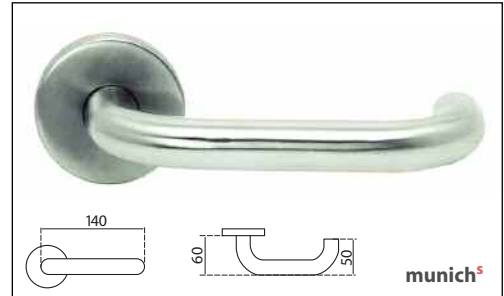

diagram measurements are mm

product notes: clockwise from left

Frankfurt - #81ST002 - lever dimension: 5-3/8"

Munich - #81ST001 - lever dimension: 5-1/2"

Stockholm - #81ST000 - lever dimension: 5-3/8"

Koln - #81ST003 - lever dimension: 5-3/8"

Vienna - #81ST028 - lever dimension: 5-3/8"

s = stocked in Los Angeles

TRIMCO manufactures a wide range of lever handles for the discriminating designer, adapted to either a mortise lock for security entrances or to tubular latches for interior doors. Dummy trim is also available.

TRIMCO has produced door hardware for over 50 years, and is now one of the leading architectural hardware manufacturers in the United States. We offer our locksets with over thirty standard levers, reasonably priced for mid-to-large size commercial projects.

The Mortise Locks supplied by TRIMCO with the urbān series are designed with the highest quality materials and components to provide high security, performance and durability. They are well-suited for commercial facilities with exterior doors including office, hotels, and high rise condominiums. In residential or commercial projects, the mortise locks are warranted for life.

Mortise locks are furnished standard with 2-3/4" backset and for doors 1-3/4" to 2-1/4" thick and the handing is field reversible. A complete set of functions is available. The latch and deadbolt are made of stainless steel, meet ANSI A 156.13, Grade 1 and are UL Listed, 3 hour fire-rated.

TRIMCO designs are provided with either a full escutcheon plate or with a matching decorative rose. The escutcheon plate may be embossed with ornamental or information based on client requirements.

TRIMCO provides high-quality, heavy-duty grade tubular latches for passage and privacy as well as mortise bolts with matching thumb-turn trim. TRIMCO levers are supplied with an additional spring-cage in the rose to ensure that the lever remains horizontal.

lever handles and related accessories



Entry Mortise with Deadbolt



Escutcheon Trim and Rose Trim

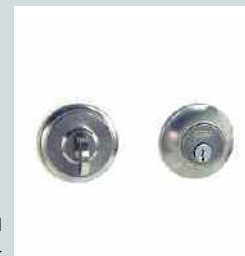

Deadbolts and Tubular Latchbolt



available in 2-3/8" and 2-3/4" backsets

To compliment the design of your door hardware selection, TRIMCO offers a range of bathroom accessories and cabinet hardware. Towel bars, coat hooks, cabinet pulls and knobs are all available in satin stainless and polished stainless steel.

Bath Accessories

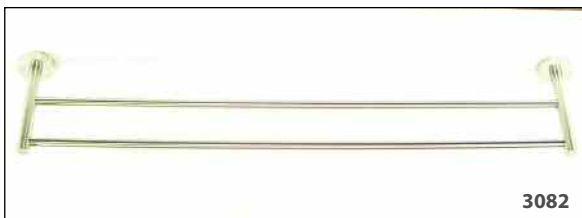
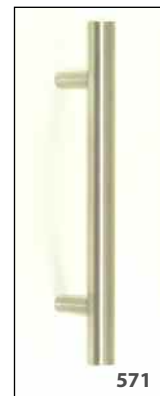
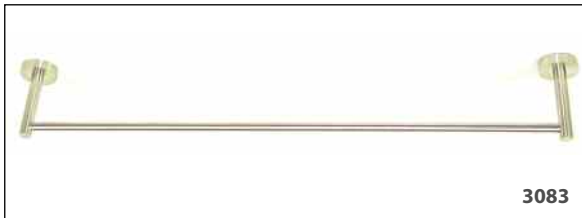

product notes: from left

Towel Bar **3061** (top left), 3/4" diameter. 18", 24", 30" & 36" – Standard. Custom size available.
 Towel Bar **3062** (second left), 3/4" diameter. 18", 24", 30", 36" – Standard. Custom size available.
 Towel Bar **3083** (third left), 1/2" diameter. 18", 24", 30", 36" – Standard. Custom size available.
 Towel Bar **3082** (bottom left), 1/2" diameter. 18", 24", 30", 36" – Standard. Custom size available.
 Coat Hook **3071**, Coat Hook **3072**, Coat Hook **3073**
 Cabinet Pull **571**, 1/2" diameter. 6", 8" & 10" – Standard. Custom size available.
 Towel Ring **3084**
 Toilet Paper Roll Holder **3080, 3081**

Appliance Pulls

As a compliment to the fine Urban locks, we now offer a selection of matching Urban Appliance Pulls. Urban Appliance Pulls provide a contemporary look and function using the same grade of stainless steel as the rest of the Urban line. TRIMCO Stainless Steel Appliance Pulls shine with a luminescent beauty that is easy to maintain.



product notes: from left

Appliance Pull **3062**: 3/4" diameter. 6", 8", 10", 12", 18", 24", 30", 36", 42", 48" center to center standard. Can be made to order.

Appliance Pull **1195**: 1" diameter. 8", 10", 12", 18", 24", 30", 36", 42", 48" center to center standard. Can be made to order.

Appliance Pull **548**: 5/16" diameter. 3" and 4" center to center standard.



TRIMCO began its door hardware business in 1949 as TRIANGLE BRASS. Now a full spectrum manufacturer, TRIMCO specializes in top quality hardware for public buildings, schools, offices, and retail stores.

Our philosophy is based on three principles:

- Produce superior quality functional hardware.
- Produce creative and attractive products.
- Produce our quality products in the United States.

Knowledgeable and professional Sales Representatives and Support Staff are eager to serve our valued customers.

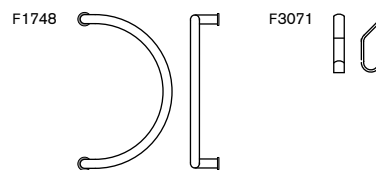
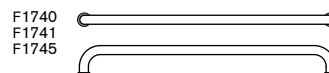
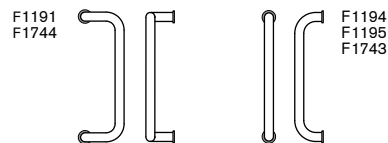
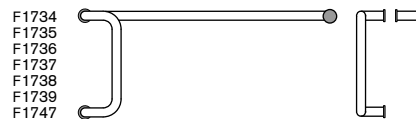

TRIMCO hardware is made with no compromise in quality, design or durability. Only full-sized, first quality extrusions, sheet stock, and castings are used. Careful machining, polishing, assembly and finishing result in a final product, which we present with pride. We warrant that our products are generally fit for the purpose for which they were designed. Properly selected, installed and not abused, they will serve the purpose for which they were intended for many years.

TRIANGLE BRASS MANUFACTURING COMPANY, INC.

P.O. Box 23277 | 3528 EMERY STREET | LOS ANGELES, CA | 90023-0277 | USA
 TEL. 323/262-4191 | FAX. 323/264-7214 OR 800/637-TRIM | trimcobbw.com